

**Sungale**

PF803



*Digital Photo Frame  
User's Manual*



For ongoing product improvement, this manual is subject to modification without prior notice.

## User Notice

---

This product has met electronic emissions standards required. It can be used safely at home.



## Contents

---

### Before Operation

---

Product Introduction	2
Safety Precautions	3
Package Contents	5
Photo Frame Overview	6

### Basic Operation

---

Power Connection	7
Insert a memory card	8
Photos	9

### Advanced Operation

---

Setting	11
---------	----

### Customer Management

---

Question&Answer	14
Troubleshooting	14
Specifications	15
FCC and safety information	16

# Before Operation

---

## Product Introduction

---

Our Digital Photo Frame is a convenient image frame that keeps your favorite images at your fingertips.

With its bright and vivid LCD screen, the Digital Photo Frame eliminates the need for tedious photo printing and injects a new level of convenience into your life.

With its diverse file management functions, this Digital Photo Frame allows you to relive wonderful memories anytime.

You can use the Digital Photo Frame to enjoy memories by presenting them with refined images.

# Before Operations

## Safety Precautions

Please read the following guidelines carefully to ensure user safety.

### Power Precautions

**⚠ WARNING:** indicates information that, if neglected, could result in serious injury and/or death to the user.

**⚠ CAUTION:** indicates information that, if neglected, could result injury to the user and/or material damage.

**01. Use only the authorized power supply product.** Failure to do so could result in product malfunction.



**02. When connecting the power source, make sure that your hands are free of moisture.** Failure to do so could result in electrical shock.



**03. Make sure that the power supply is firmly plugged in and not loose.** Failure to do so could result in electrical shock.

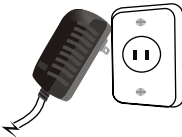

**04. Do not let the power cord get overly entangled and do not place any heavy objects on the cord.** Failure to do so could result in electrical shock.

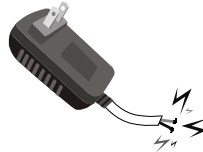

**05. Do not connect the power supply to an electrical power strip with other various connections.** Failure to do so could result in fire.

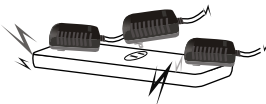

**06. Disconnect the power supply during inclement weather conditions that include thunder and lightning.** Failure to do so could result in fire.



# Before Operations

---

## Safety Precautions

---

Please read the following guidelines carefully to ensure user safety and avoid malfunction.

### Product Related Precautions

01. Dropping the product or subjecting it to a significant impact can cause critical damage.

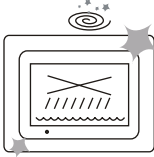

02. Spilling water or any other liquid on the product can cause critical damage.



03. Striking or scratching the LCD screen may cause critical damage.

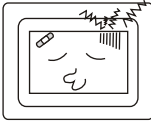

04. When cleaning the LCD screen, turn off the power and wipe it gently with a soft cloth.

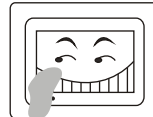

05. Do not subject the product to severe humidity and/or heat.

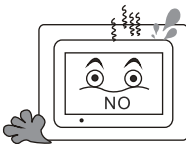

06. Make sure to power off the unit before disconnecting the power supply.

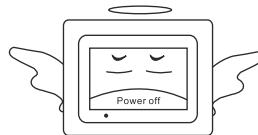

# Before Operations

---

## Package Contents

---

For the improvement of product performance and/or quality, the basic components may be modified without prior notice. The components may differ slightly in appearance with the provided images.



Digital Photo Frame

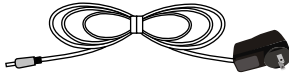

Power Adapter



Quick Start Guide

# Before Operations

---

## Photo Frame Overview

---

The package contents may differ slightly in appearance with the provided images

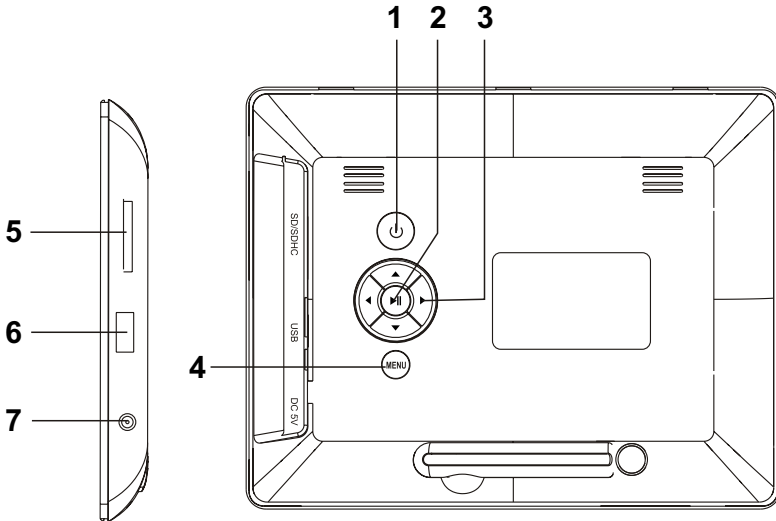

- 1. Power:** Press to turn on or turn off the DPF player.
- 2. Play / Pause:** Press to enter / confirm; Press to pause when slideshow pictures and press again to continue slideshow.
- 3. Navigation button**
  - Press ◀ to move left ( rotate a picture by left 90<sup>0</sup> when browser mode).
  - Press ▶ to move right ( rotate a picture by right 90<sup>0</sup> when browser mode).
  - Press ▲ to move the cursor to the previous icon or skip to the previous picture.
  - Press ▼ to move the cursor to the next icon or skip to the next picture.
- 4. Menu:** Back to last step.
- 5. SD/SDHC:** Insert one of the SD/SDHC cards each time.
- 6. USB:** Insert a USB flash stick.
- 7. 5V DC IN:** Insert the power adaptor cord to connect the unit with power outlet.

# Basic Operations

---

## Power Connection

---

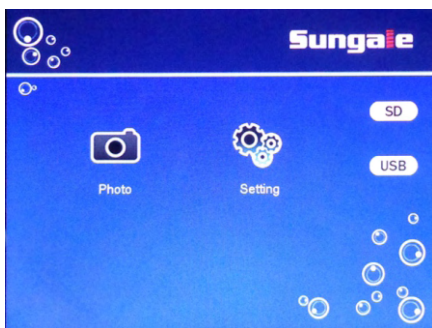

3

1. Connect the power adapter to the DC IN jack on the left side of the frame.
2. Plug in the power socket.
3. The frame will automatically power on.



# Basic Operations

---

## Insert a memory card

---

Insert card in the direction indicated by the arrow on the top of the card (the side of the memory card on which sticker is affixed face the frame).

SD/SDHC card is compatible with this unit.

Aligning the memory card upside down may cause user-error damage.

This may nullify the warranty.

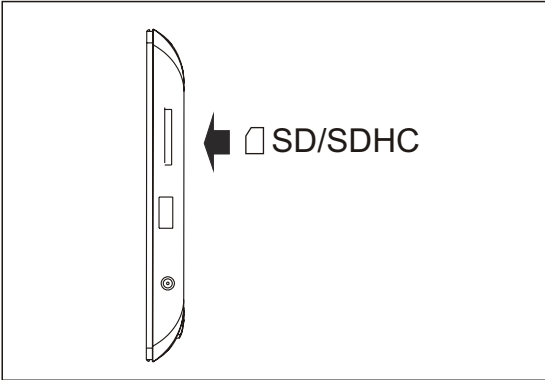

## USB Removable Storage Devices

Insert USB removable storage device into the USB port on the side of the frame.

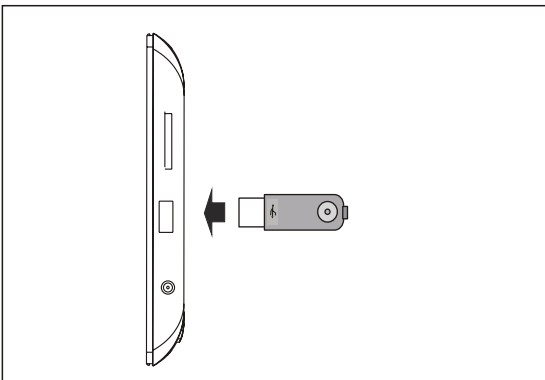

NOTE: This device will read USB first and will not recognise the memory card if you insert a memory card and extra USB memory together at the same time.

# Basic Operations

---

## Insert a memory card

---

### Removing the Memory Card

When removing a memory card from the frame, pull the card straight away from the unit. Avoid bending the card.

### Select SD card or USB device

On the main menu, press MENU, and select to read SD card or USB device.

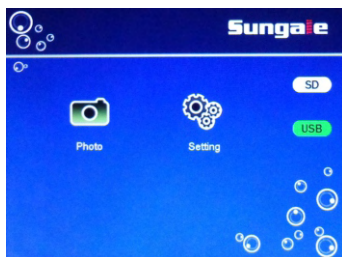

## Photos

---

### Display Photos

**Note:** The frame will display pictures in the memory card or USB device automatically if there is a memory card or USB device is inserted to the frame before connecting power.

In the main menu, select PHOTO icon and press  to play the photos.

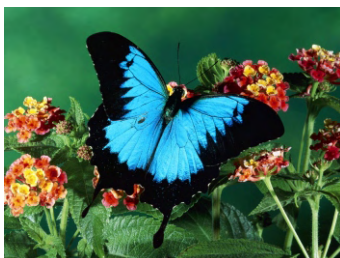
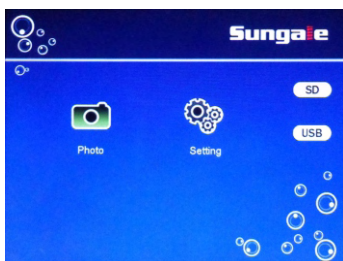

# Basic Operations

---

## Photos

---

### Thumbnail Mode

When displaying, press ◀ or ▶ to move to previous or next photo, press MENU to enter into Thumbnail Mode.

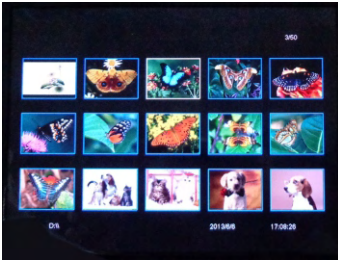

### Rotate a Photo

When displaying images, press the navigation key to rotate the displaying photo for 90° once an operation.

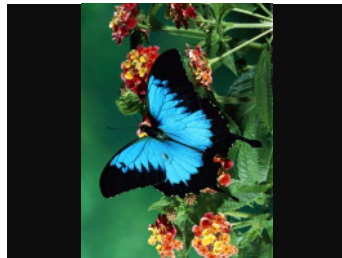

# Basic Operations

---

## Setting

---

### Enter Setting Interface

**Tip 1.** Press the ◀ / ▶ button to enter the Setting interface.

**Tip 2.** Select Setting icon in the main menu and press ▶| to enter Setting interface.

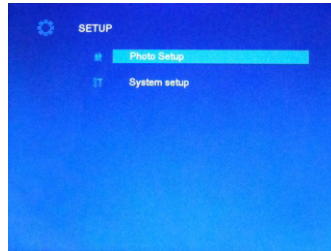
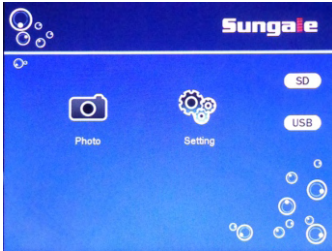

**Tip 3.** Choose Photo setup and System setup, and press ▶| to setup.

### Setting Menu guide

Press "▲" or "▼" to select the setting item, and press ▶| to confirm.  
Press "◀" or "▶" to change the value.

# Advanced Operations

---

## Setting

---

### Photo Set up:

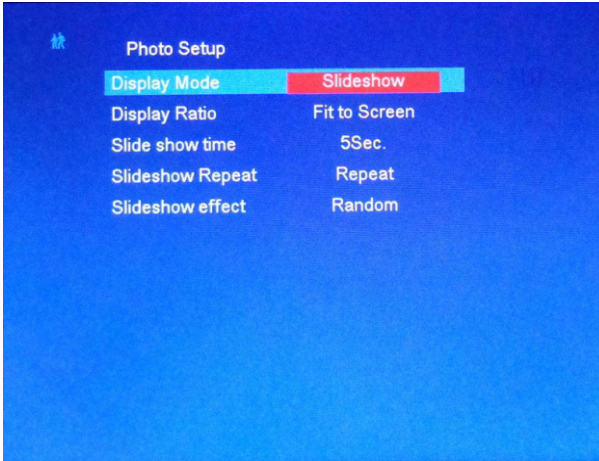

#### Display Mode

Select to set the display mode to preview photos in slideshow mode, browse mode or Thumbnail mode.

#### Display Ratio

Select to set the photo displaying type

#### Slide show time

Select to set the time the photo remains on the screen in slideshow mode.

#### Slideshow Repeat

Select to set slideshow repeatedly or once.

#### Slideshow Effect

Select to set the transfer effect in slideshow mode

# Advanced Operations

---

## Setting

---

### System setup

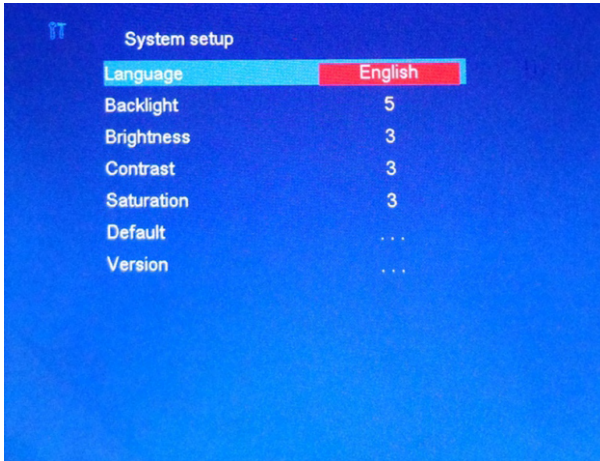

#### Language

Select to set display language

#### Backlight

Adjust the brightness that illuminates from behind of the screen.

#### Brightness

Select to adjust the brightness of the screen

#### Contrast

Select to adjust the contrast of the screen.

#### Saturation

Select to adjust the saturation of the screen.

#### Default

Reset the product to factory default.

#### Version

Select to show the software number

# Advanced Operations

---

## Question & Answer

---

This chapter will attempt to solve common problems that one may experience with the Multimedia DPF. If this guide does not solve your problem, do not dismantle the machine yourself.

Question	Answer
What is the main function of the digital photo frame?	Using the digital photo frame, you can display images, calendar and clock.
What memory card are compatible with the digital photo frame?	The unit can be compatible with SD/SDHC card
Why picture display seems slow?	You are viewing high-resolution pictures, it can take some time to display.
Why the unit can't display pictures?	Make sure the pictures are in JPEG format. Make sure you have inserted a card or USB device properly and selected the PHOTO icon in the main menu.
How can I see the photo file list?	Please set display mode of photo to Thumbnail. you can see the photo file list in thumbnail mode.

## Troubleshooting

---

Some simple checks or a minor adjustment eliminate common problems:

### No power

1. Check the power button is on.
2. Check the power outlet is operational.
3. Check the power cord is no damaged.
4. Check the power plug is firmly connected to photo frame.

### Can not read the card

1. Check the card is no damaged.
2. Check the card is connected the photo frame correctly.
3. Pull out the card, and then insert again.

### Photo Frame is not working

Turn off the power, and then turn it on again.

# Customer Management

---

## Specifications

---

Display: 8" TFT LCD Digital Screen

Resolution: 800(RGB) x 600 (Pixels) (4:3)

Power: AC Adapter, Input 110-220V ; Output 5V

### **Environmental operating ranges**

Operation: 32~95 F, Humidity 0~85%

Storage: -4~140 F, Humidity 10~90%

Note: All data are provided for reference purposes only. Sungale reserves the right to make any changes without prior notice.



## **FCC and Safety Information**

---

### **• FCC Part 15.19**

This device complies with Part 15 of the FCC Rules .Operation is subject to the following two conditions: (1) this device may not cause harmful interference , and (2) this device must accept any interference received ,including interference that may cause undesired operation .

### **• FCC part 15.21**

Warning: Changes or modifications to this unit not expressly approved by the party responsible for compliance could void the user's authority to operate the equipment.

### **• FCC part 15.105**

Note : This equipment has been tested and found to comply with the limits for a Class B digital device ,pursuant to Part 15 of the FCC Rules, These limits are designed to provide reasonable protection against harmful interference in a residential installation .This equipment generates, uses, and can radiate radio frequency energy and ,if not installed and used in accordance with the instructions, may cause harmful interference will not occur in a particular installation .If this equipment does cause harmful interference to radio or television reception ,which can be determined by turning the equipment off and on ,the user is encouraged to correct the interference by one or more of the following measures:

- Reorient or relocate the receiving antenna.
- Increase the separation between the equipment and receiver.
- Connect the equipment into an outlet on circuit different from that to which the receiver is connected.
- Consult the dealer or an experienced radio TV technician for help.

# LIMITED WARRANTY

The limited warranty set forth below is given by the manufacturer with respect to Sungale brand DPF players and other consumer electronics products purchased and used in the United States of America. The manufacturer warrants this product against defects in material or workmanship as follows:

**LABOR:** For a period of ninety (90) days from the date of purchase if this Product is defective, the manufacturer will repair or replace the Product, at its option, at no charge. After this ninety (90) days period up to one year, a labor charge of US\$30.00 will be charged for each service.

**PARTS:** For a period of one year from the date of purchase, the manufacturer will supply, at no charge, new or rebuilt replacement parts in exchange for defective parts. After this one year period, the manufacturer will charge the new or replacement parts.

This warranty does not cover: (1) customer instruction, installation or set up; (2) cosmetic damage or damage due to accident, misuse, abuse, or negligence; (3) commercial use of the Product; (4) modification of any part of the Product; (5) damage due to improper operation, improper maintenance, or connection to an improper voltage supply; (6) damage due to an attempted repair of the Product by anyone other than a facility authorized by the manufacturer to service the Product; (7) consumables (such as fuses and batteries). This warranty is valid only in the United States.

The product must be accompanied by a copy of the original retail purchase receipt. If no proof of purchase is attached, the warranty will not be honored and repair cost will be charged.

This warranty is valid with attach written documentation detailing the complaint to the outside or inside of the carton.

This warranty is invalid if the factory applied serial number has been altered or removed from the Product.

The manufacturer reserves the right to modify any design of this product without prior notice.

To obtain warranty service, you must deliver the product freight prepaid, in either its original packaging or packaging affording an equal degree of protection, plus proof of purchase, to:

Service Center  
13941 Central Ave,  
Chino, CA 91710  
Tel: **800-473-5156**

REPAIR OR REPLACEMENT AS PROVIDED UNDER THIS WARRANTY IS THE EXCLUSIVE REMEDY OF THE CONSUMER. THE SERVICE CENTER SHALL NOT BE LIABLE FOR ANY INCIDENTAL OR CONSEQUENTIAL DAMAGES FOR BREACH OF ANY EXPRESS OR IMPLIED WARRANTY ON THIS PRODUCT. EXCEPT TO THE EXTENT PROHIBITED BY APPLICABLE LAW, ANY IMPLIED WARRANTY OF MERCHANTABILITY OR FITNESS FOR A PARTICULAR PURPOSE ON THIS PRODUCT IS LIMITED IN DURATION TO THE DURATION OF THIS WARRANTY.

Some states do not allow the exclusion or limitation of incidental or consequential damages, or allow limitations on how long an implied warranty lasts, so the above limitations or exclusions may not apply to you. This warranty gives you specific legal rights, and you may have other rights which vary from state to state.

Digital Photo Frame

**Sungale**